

Installation Guide

i.DEER

Series C8

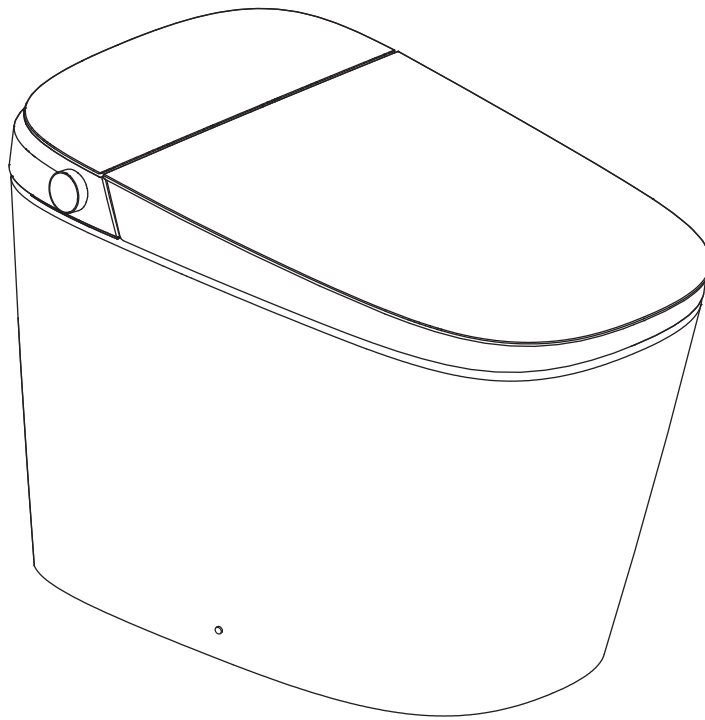

Compliance with
cUPC (Uniform Plumbing code)
EGS (IAPMO - Electrical Product)

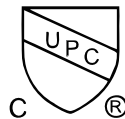

NRTL
IAPMO[®] UL 1431
EGS CSA C22.2
us Nos.64 and 68

www.ideer.land

Table of Content

Cautions and Warnings	_____	01
Technical Specification	_____	05
FCC / IC Statement	_____	06
Component Details	_____	07
Preparation	_____	08
Installation Guide	_____	09
Remote Control Installation	_____	11
Before the initial use	_____	12
Troubleshooting Guide	_____	13

IMPORTANT SAFEGUARDS

When using electrical products, especially when children are present, basic safety precautions should always be followed, including the following:

1. The appliance is not to be used by persons (including children) with reduced physical, sensory or mental capabilities, or lack of experience and knowledge, unless they have been given supervision or instruction.
2. This appliance can be used by children aged from 8 years and above and persons with reduced physical, sensory or mental capabilities or lack of experience and knowledge if they have been given supervision or instruction concerning use of the appliance in a safe way and understand the hazards involved.
3. Children shall not play with the appliance.
4. Cleaning and user maintenance shall not be made by children without supervision.

READ ALL INSTRUCTIONS BEFORE USING



DANGER – To reduce the risk of electrocution:

1. Do not use while bathing.
2. Do not place or store product where it can fall or be pulled into a tub or sink.
3. Do not place in or drop into water or other liquid.
4. Do not reach for a product that has fallen into water. Unplug immediately.
5. Do not wash the main unit or electrical plug with water or detergent.
6. Do not handle the electrical plug with wet hands.
7. Never block the outlet of the air dryer.
8. Never disassemble, repair or modify this product.
9. During installation, disassembly, repair and maintenance of the product, the power plug must be switched off and water supply be shut off.



DANGER – Réduire le risque d'électrocution:

1. Ne pas utiliser pendant le bain.
2. Ne pas placer ou stocker le produit dans un endroit où il pourrait tomber ou être tiré dans une baignoire ou un évier.
3. Ne pas placer ou laisser tomber le produit dans l'eau ou tout autre liquide.
4. Ne tendez pas la main pour obtenir le produit tombé dans l'eau. Débranchez immédiatement la prise.
5. Ne lavez pas l'unité principale ou les prises électriques avec de l'eau ou des détergents.
6. Ne pas manipuler la prise électrique avec les mains mouillées.
7. Ne jamais obstruer la sortie du sècheur d'air.
8. Ne jamais démonter, réparer ou modifier ce produit.
9. À l'occasion de l'installation, du démontage, de la réparation et de l'entretien du produit, la prise de courant doit être coupée et l'alimentation en eau doit être interrompue.



WARNING – To reduce the risk of burns, electrocution, fire, or injury to persons.

1. Close supervision is necessary when this product is used by, on, or near children or individuals with disabilities.
2. Use this product only for its intended use as described in this manual. Do not use attachments not recommended by the manufacturer.
3. Never operate this product if it has a damaged cord or plug, if it is not working properly, if it has been dropped or damaged, or dropped into water. Return the product to a service center for examination and repair.

4. Keep the cord away from heated surfaces.
5. Never use while sleeping or drowsy.
6. Never drop or insert any object into any opening or hose.
7. Do not use outdoors or operate where aerosol (spray) products are being used or where oxygen is being administered.
8. Connect this product to a properly grounded outlet only. See Grounding Instructions.
9. Do not throw cigarettes and other burning materials into toilet, otherwise it might cause fire.
10. This product is an electric appliance, so it must be placed far away from water and other liquid.
11. Do not lay the product on its side or upside down during the electrical circuit.
12. It is prohibited to use other electric appliances in the same socket.
13. It is forbidden to use the power extension or unstable loose outlet.
14. Do not reuse any existing water supply hoses, otherwise it might cause leakage, fire or electrical shock. Installation should include specified components and a new water supply hose.



AVERTISSEMENT – *Pour réduire les risques de brûlure, d'électrocution, d'incendie ou de blessure.*

1. *Ce produit doit être surveillé de près lorsqu'il est utilisé par, sur ou à proximité d'enfants ou de personnes handicapées.*
2. *N'utilisez ce produit que pour l'usage auquel il est destiné, tel qu'il est décrit dans ce manuel. N'utilisez pas d'accessoires non recommandés par le fabricant.*
3. *N'utilisez jamais ce produit si le cordon ou la fiche est endommagé, ne fonctionne pas correctement, tombe ou est endommagé, ou tombe dans l'eau. Retourner le produit au centre de service pour inspection et réparation.*
4. *Gardez le cordon loin des surfaces chaudes.*
5. *Ne jamais utiliser pendant le sommeil ou la somnolence.*
6. *Ne laissez jamais tomber ou n'insérez jamais d'objet dans une ouverture ou un tuyau.*
7. *Ne pas utiliser à l'extérieur ou dans des endroits où des aérosols (sprays) ou de l'oxygène sont utilisés.*
8. *Connectez ce produit uniquement aux prises correctement mises à la terre. Voir les instructions de mise à la terre.*
9. *Ne jetez pas de cigarettes et autres substances brûlées dans les toilettes, sinon cela pourrait provoquer un incendie.*
10. *Ce produit est un appareil électrique et doit donc être placé loin de l'eau et d'autres liquides.*
11. *Dans le circuit, ne pas allonger le produit sur le côté ou à l'envers.*
12. *L'utilisation d'autres appareils électriques dans la même prise est interdite.*
13. *Il est interdit d'utiliser des rallonges d'alimentation ou des prises lâches instables.*
14. *Ne réutilisez pas les tuyaux d'alimentation existants, car ils pourraient provoquer une fuite, un incendie ou une électrocution. L'installation doit inclure les composants spécifiés et un nouveau tuyau d'alimentation en eau.*

IMPORTANT SAFETY INSTRUCTIONS



CAUTION – Indicates that failure to follow the instruction may cause body injury or property damage.

1. Do not install or use the product in wet places as steam room etc.
2. It is recommended to use water-proof electrical outlet which should be installed in a place where is not easily to get wet.
3. This product should be used with 110V-120V, 50Hz-60Hz electrical current only, load current is at least 15A. Power plug must be equipped with ground fault circuit interrupter or ground fault electrical leakage protector or similar high sensitive, rapid type leakage switch (Rated sensitive current under 6mA).
4. When it thunders, it is strongly recommended to pull out the power plug.
5. Do not stand on ceramic toilet.
6. Ceramic toilet must install floor fixing bolts.
7. Do not stand on product unit, seat and lid.
8. Do not lean against the seat lid when using the product, to avoid damage.
9. This product is equipped with a soft-closing seat lid. Do not push the toilet seat closed, or damage may occur.
10. Do not use any caustic chemicals or scrubbing brush to clean this product.
11. Exposure to direct sunlight is prohibited.
12. Only use tap water or potable water, otherwise it may cause chafing.
13. Do not connect water supply to heater outlet. Make sure inlet water temperature is between 3~35°C/37.4~95°F.
14. When the room temperature is under zero degree, please drain the water tank, to avoid freezing.
15. Raise room temperature to prevent the toilet from damage due to freezing.
16. When moving the product from cold or wet environment into normal room temperature, wait for 2 hours until the condensation water is fully volatilized. Doing so can prevent the product from electrical short-circuit.
17. When not using the product over three(3) days, drain the water out of the toilet and pull the electrical plug from the wall outlet.
18. Stop using the product and shut off the power when product malfunctions. Call for professional service.



ATTENTION – *Indique que le non-respect de l'instruction peut entraîner des blessures corporelles ou des dommages matériels.*

1. *N'installez pas ou n'utilisez pas le produit dans un endroit humide, tel qu'une chambre à vapeur, etc.*
2. *Il est recommandé d'utiliser une prise de courant étanche, qui doit être installée dans un endroit où elle ne risque pas d'être mouillée.*
3. *Ce produit doit être utilisé avec un courant électrique de 110V-120V, 50Hz-60Hz uniquement, le courant de charge étant d'au moins 15A. La fiche d'alimentation doit être munie d'un disjoncteur de défaut de mise à la terre ou d'un protecteur de fuite de défaut de mise à la terre ou d'un interrupteur de fuite de type rapide de haute sensibilité similaire (courant sensible nominal inférieur à 6 ma).*
4. *En cas de tonnerre, il est fortement recommandé de débrancher la prise électrique.*
5. *Ne vous tenez pas debout sur les toilettes en céramique.*
6. *Les toilettes en céramique doivent être équipées de boulons de fixation au sol.*
7. *Ne pas se tenir debout sur l'unité de produit, le siège et le couvercle.*
8. *Ne vous appuyez pas sur le couvercle du siège lorsque vous utilisez le produit, afin d'éviter de l'endommager.*
9. *Le produit est équipé d'un couvercle de siège à fermeture douce. Ne fermez pas le siège de toilette, il pourrait causer des dommages.*
10. *N'utilisez pas de produits chimiques agressifs ou de brosses pour nettoyer ce produit.*

11. L'exposition directe au soleil est interdite.
12. Utilisez uniquement de l'eau du robinet ou de l'eau potable, sinon vous risquez de causer des éraflures.
13. Ne raccordez pas l'alimentation en eau à la sortie de l'appareil de chauffage. S'assurer que la température de l'eau d'entrée est comprise entre 3~35°C/37.4~95°F.
14. Lorsque la température ambiante est inférieure à zéro degré, veuillez vidanger le réservoir d'eau afin d'éviter le gel.
15. Augmentez la température de la pièce pour éviter que les toilettes ne soient endommagées par le givrage.
16. Lorsque le produit passe d'un environnement froid ou humide à une température ambiante normale, attendre 2 heures jusqu'à ce que l'eau de condensation soit entièrement volatilisée. Ce faisant, vous évitez les courts - circuits électriques du produit.
17. Lorsque le produit n'est pas utilisé pendant plus de trois (3) jours, videz l'eau des toilettes et débranchez la prise électrique de la prise murale.
18. Cessez d'utiliser le produit et éteignez l'alimentation lorsque le produit tombe en panne. Appel à un service professionnel.

GROUNDING INSTRUCTIONS

This product should be grounded. In the event of an electrical short circuit, grounding reduces the risk of electric shock by providing an escape wire for the electric current. This product is equipped with a cord having a grounding wire with a grounding plug. The plug must be plugged into an outlet that is properly installed and grounded.



DANGER – Improper use of the grounding plug can result in a risk of electric shock.

If repair or replacement of the cord or plug is necessary, do not connect the grounding wire to either flat blade terminal. The wire with insulation having an outer surface that is green with or without yellow stripes is the grounding wire.

This product is factory equipped with a specific electric cord and plug to permit connection to a proper electric circuit. Make sure that the product is connected to an outlet having the same configuration as the plug. No adapter should be used with this product. Do not modify the plug provided — if it will not fit the outlet, have the proper outlet installed by a qualified electrician. If the product must be reconnected for use on a different type of electric circuit, the reconnection should be made by qualified service personnel.



DANGER - une mauvaise utilisation de la prise de terre peut entraîner un risque d'électrocution.

Si vous avez besoin de réparer ou de remplacer un fil ou une fiche, ne connectez pas le câble de mise à la terre à une borne de type lame plate. Les fils avec une couche isolante dont la surface extérieure est verte et avec ou sans bandes jaunes sont des fils de terre.

Ce produit est équipé en usine d'un cordon électrique et d'une fiche spécifiques permettant de le connecter à un circuit électrique approprié. Assurez-vous que le produit est branché sur une prise ayant la même configuration que la fiche. Aucun adaptateur ne doit être utilisé pour ce produit. Ne modifiez pas la fiche fournie — si elle n'est pas adaptée à la prise, faites installer la prise adéquate par un électricien qualifié. Si le produit doit être reconnecté pour être utilisé sur un autre type de circuit, il doit être reconnecté par un personnel de service qualifié.

SAVE THESE INSTRUCTIONS

Technical specification

Main Unit	Rated voltage	110V-120V, 50Hz-60Hz
	Rated power	875W
	Water proof	IPX4
	Power cord length	About 4.92ft (1.5m)
Toilet	Flush volume	1.6/1.1Gpf, 6.0L(full flush)/4.1L(half flush)
	Flushing mode	Siphonic jet
	Rough-in	12" (305mm)
	Outlet outside diameter	≤3.9" (100mm)
	Drainage method	S-trap
Cleaning device	Water pressure range	Minimum water pressure 0.08MPa, Maximum water pressure 0.8MPa
	Heating mode	Instant
	Heating power	120V/1400W
	Water temperature	6-level adjustment
	Water volume	3-level adjustment
	Cleaning mode	Rear washing / Oscillating washing, Front washing / Oscillating washing
	Nozzle position	5-level adjustment
	Water pressure protector	Pressure maintaining device, Automatic pressure relief device
Drying device	Anti-fouling device	Automatic nozzle cleaning, Anti-syphon device, Anti-backflow device, Filter device
	Safety device	Thermal fuse, Water temperature sensor, thermostat, Over temperature protection, Ground protection, Leakage protection plug
	Warm air volume	Over 7.1 cfm (0.2m ³ /min)
	Warm air temperature	6-level adjustment
Lid auto open / close	Heating power	200W
	Safety device	Thermal fuse, Leakage protection plug, Thermostat
Lid auto open / close	Lid opening	Radar sensing auto open / close lid
Sterilization	Sterilization device	Plasma sterilization
Deodorization	Deodorization method	Photocatalyst-Free
Heated seat	Surface temperature	6-level adjustment
	Heating power	50W
	Open and close device	Quiet soft-close
	Burn protection	After 10 minutes of use, the seat temperature will automatically drop slowly to a low level
	Safety device	Seat sensor, Temperature sensor, Thermal fuse, Thermostat, Leakage protection plug
Caring device	Night light assembly	Intelligent, Always off, Always on
	User ID setting	To avoid interference when used by multiple users
	Automatic flushing	Automatically flushing after use
	Auto open lid	Auto open lid function
	Foot sensor open lid	Foot sensor open lid and seat
	Foot sensor flushing function	Foot sensor flushing
Antibacterial site		Seat, nozzle

Rated power: Under the condition of ambient temperature 73°F/23°C, water static pressure 0.18MPa ± 0.02MPa, water temperature 59°F/15°C, power toilet on, set water pressure, seat temperature, water temperature to the highest level in turn and perform one rear washing cycle.

FCC Statement

This device complies with Part 15 of the FCC Rules. Operation is subject to the following two conditions:

- (1) This device may not cause harmful interference, and
- (2) this device must accept any interference received, including interference that may cause undesired operation.

NOTE: This equipment has been tested and found to comply with the limits for a Class B digital device, pursuant to Part 15 of the FCC Rules. These limits are designed to provide reasonable protection against harmful interference in a residential installation. This equipment generates uses and can radiate radio frequency energy and, if not installed and used in accordance with the instructions, may cause harmful interference to radio communications. However, there is no guarantee that interference will not occur in a particular installation. If this equipment does cause harmful interference to radio or television reception, which can be determined by turning the equipment off and on, the user is encouraged to try to correct the interference by one of the following measures:

- Reorient or relocate the receiving antenna.
- Increase the separation between the equipment and receiver.
- Connect the equipment into an outlet on a circuit different from that to which the receiver is connected.
- Consult the dealer or an experienced radio/TV technician for help.

WARNING: Any changes or modifications not expressly approved by the party responsible for compliance could void the user's authority to operate this equipment.

The device must not be co-located or operating in conjunction with any other antenna or transmitter.

FCC RF Radiation Exposure Statement Caution: To maintain compliance with the FCC's RF exposure guidelines, place the product at least 20cm from nearby persons.

IC Statement

This device complies with Industry Canada license-exempt RSS standard(s). Operation is subject to the following two conditions:

- (1) this device may not cause interference, and
- (2) this device must accept any interference, including interference that may cause undesired operation of the device.

Le présent appareil est conforme aux CNR d'Industrie Canada applicables aux appareils radio exempts de licence. L'exploitation est autorisée aux deux conditions suivantes : (1) l'appareil ne doit pas produire de brouillage, et (2) l'utilisateur de l'appareil doit accepter tout brouillage radioélectrique subi, même si le brouillage est susceptible d'en compromettre le fonctionnement.

This equipment should be installed and operated with minimum distance 20cm between the radiator & your body.

Cet équipement doit être installé et utilisé avec un minimum de 20 cm de distance entre la source de rayonnement et votre corps.

CAN ICES-003(B) / NMB-003(B).

Components Details

Product Dimensions

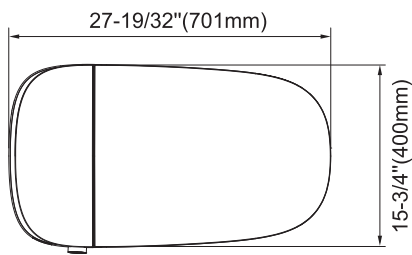
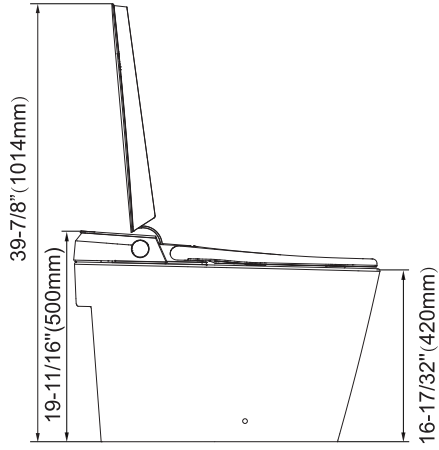

Toilet Components

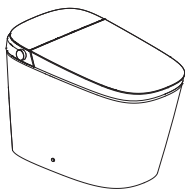

Main Unit



Sealing Flange

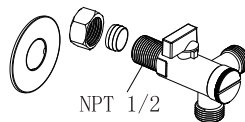

Angle Valve



Installation Cardboard

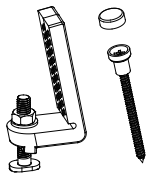

Mounting Kit



Braided Hose
(Pre Installed)



Remote Control
Components

Preparation

Tools Required for Installation



Drill with assorted bits

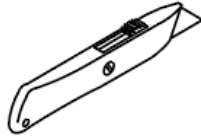

Knife



Measuring Tape



Pencil

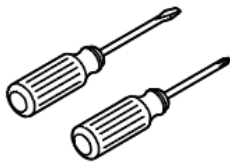

Assorted screwdrivers



Adjustable wrench



Pliers



Teflon Tape

Installation Dimensions

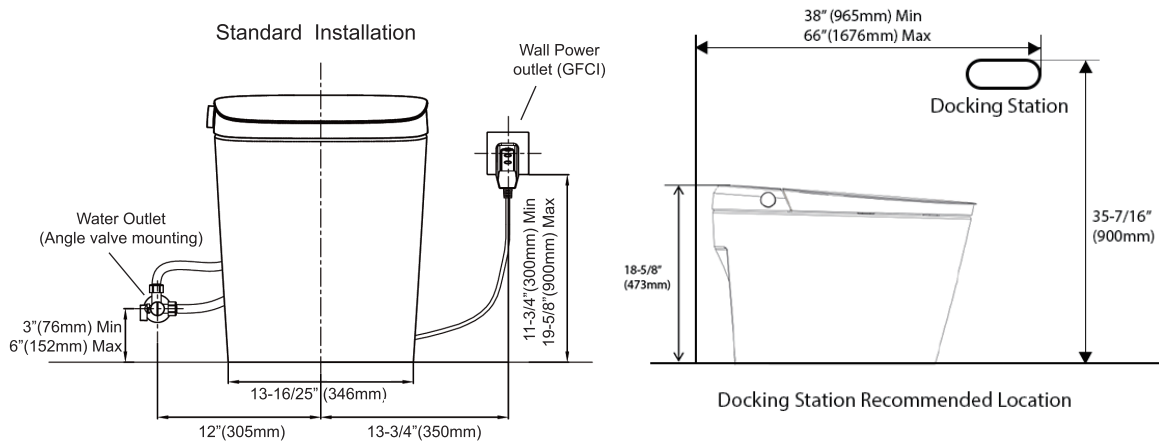

Installation Guide

1. Installation of angle valve

- Draw drain outlet centerline on the floor. Install angle valve at proper position on the wall according to the dimension of toilet.

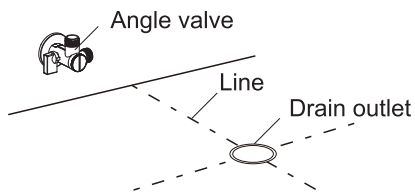

- Installation Method 1:

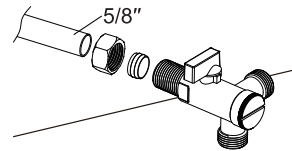

- Installation Method 2:

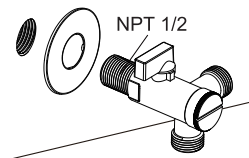

Note:

1. Please use the supplied angle valve when installing this toilet. Use of another angle valve not including a filter may result in blockages in the toilet and bidet waterways.
2. If replacing an existing angle valve, please contact a professional for installation.

2. Cardboard Reference

- Align cardboard with the centerline of drain outlet.
- Draw contour line according to cardboard.

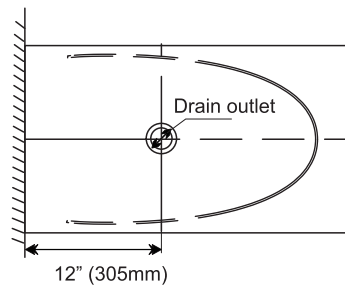

3. Mounting bracket installation

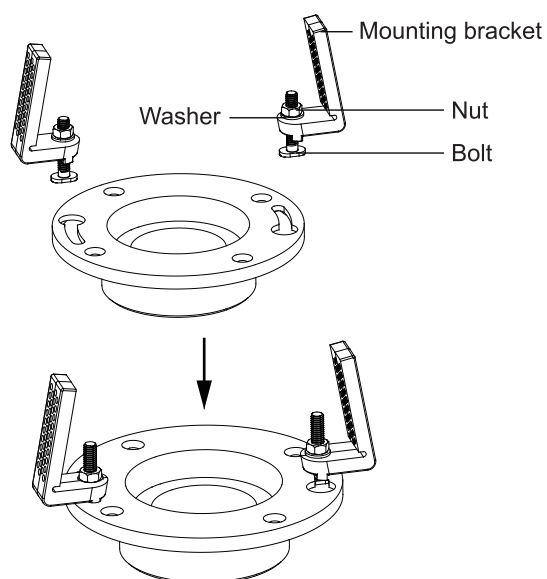

- Assemble the mounting bracket with bolts and then install them to the pre-installed flange plate on the ground and lock tight with nuts.

4. Ceramic toilet installation

- Install a sealing flange into toilet drain outlet.
- Install ceramic toilet on the corresponding position.

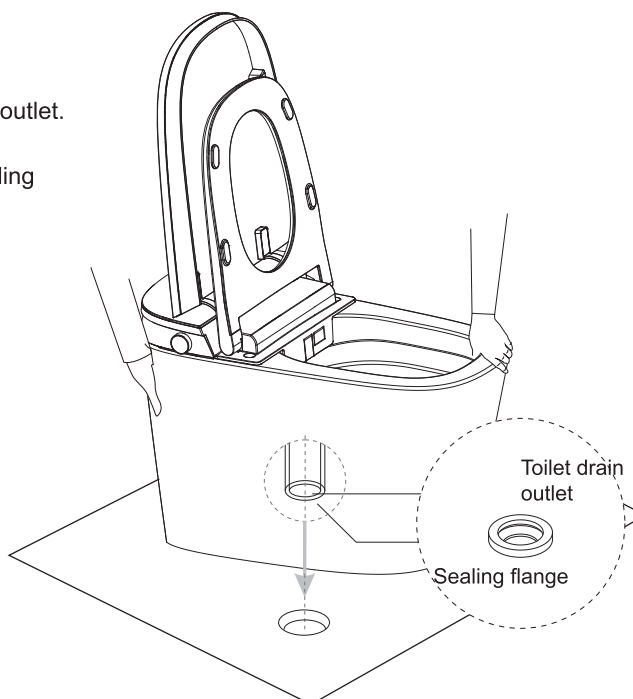

Note:

1. Two people are required to carry the toilet.
2. Please clean up the drain outlet;
3. Please make sure ceramic toilet outlet sits perfectly on drain outlet.

5. Screw installation

- Put the screw through the fixing sleeve and then install it through the holes (on both sides of the toilet ceramic) to the mounting bracket on the ground. Lock tight.
- Install the decorative cap on the fixing sleeve.

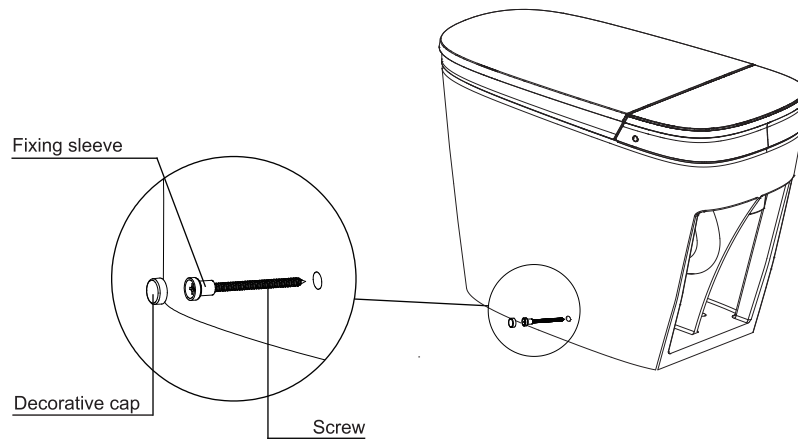

6. Hose Connection

- Connect the water supply hose of the toilet tank and the water inlet hose of the toilet seat to the three-way angle valve as shown in the figure.

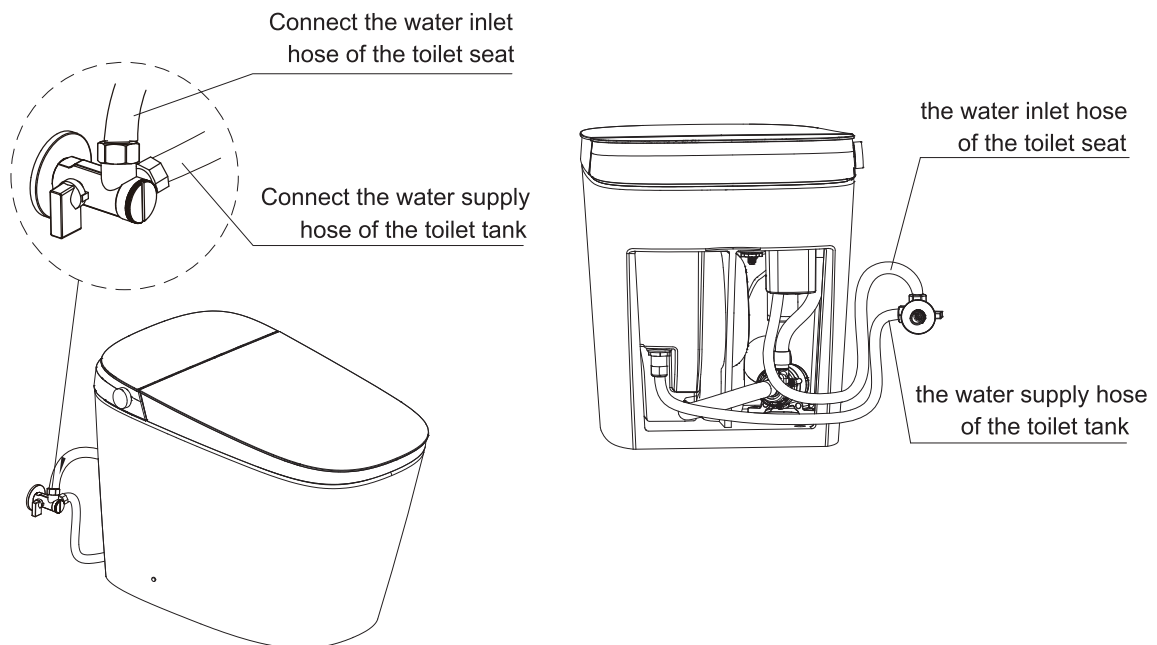

Note:
Please use this supplied water supply hose to ensure optimal flushing performance.

Remote control installation

Option 1

- Drill two 6mm diameter holes in the wall at a distance of about 130.7mm, a depth of about 35mm.
- Remove the double-sided adhesive tape on the back of the holder.
- Install an anchor in each of the holes, stick the holder to the wall and secure with screws and then stick the patch with tape.

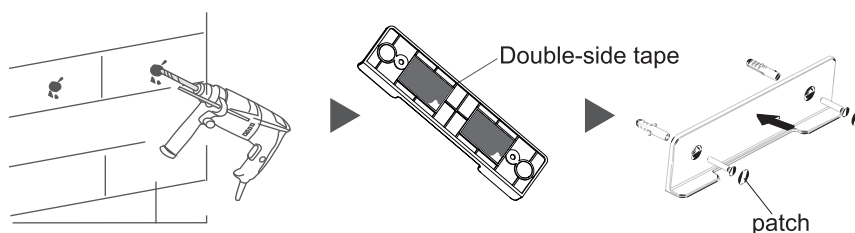

Option 2

- Clean and dry the pre-installation area of the holder.
- Remove the double-sided adhesive tape on the back of the holder.
- Stick the holder to the wall vertically and then stick the patch with tape.

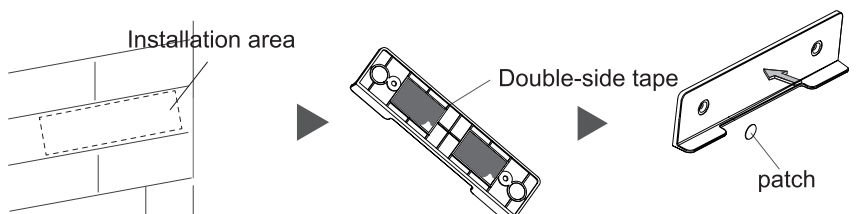

Battery installation:

- Insert batteries into the remote control.
- Put the remote control to the holder.

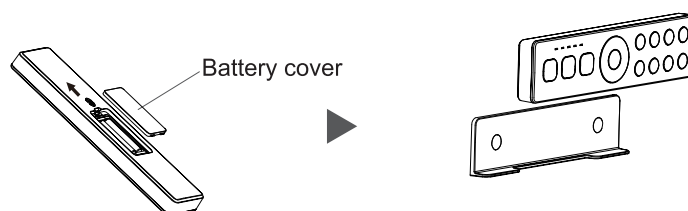

Note:

Please ensure the remote control is within reach when a person on the seat.
Do not install and use the product in damp places such as a shower room.
Do not place the product in a place where it is easily exposed to water.

Before the initial use

1. Turn on the angle valve

- Check the threaded connection for leaks to ensure complete sealing. Turn the angle valve counterclockwise to the full open position.

(Note: The Three-way angle valve opens with a large torque for the first time.)

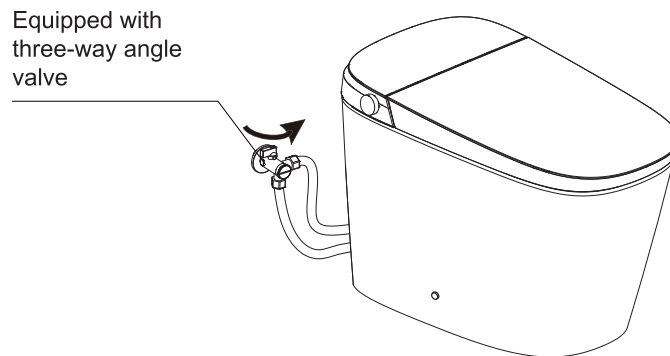

2. Power Connection

- Insert the leakage protection plug into a power socket, press the reset switch, plug indicator lights up, indicating that the power is on.

Note:
Press the test button prior to usage, the reset switch pops up indicating that the leakage protection function is normal.

Press the TEST button (then RESET button) every month to assure proper operation.

- * Only for models with leakage protection plug.
- * Please refer to the actual product.

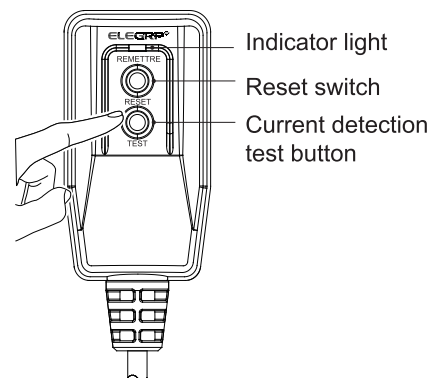

3. Self-inspection

- Once power is connected, the smart bidet toilet will start self-inspection. It's normal to hear motor and water sounds and the knob will lights up in white.
- Self-inspection includes a pre wash for the toilet bowl and pre clean the nozzle. Another beep sound indicates the completion of this process.
- Confirm battery has been correctly installed in the remote controll, and the product is ready to use.

Troubleshooting Guide

This troubleshooting guide is for general aid only. Please contact I.DEER support team for any unresolved issue. For warranty services, contact I.DEER local dealer or distributor.

Symptoms	Probable Causes	Recommend Action
Toilet does not operate	<ol style="list-style-type: none"> 1.Toilet is in "Standby" mode. 2.Product is under protected status. 3.Power failure occurred. 	<ol style="list-style-type: none"> 1.Long press the side knob to switch to "Functional" mode. 2.Press "TEST" then "RESET". on the leakage protection plug. 3.Wait until the power is restored.
Toilet does not flush automatically	<ol style="list-style-type: none"> 1.Previous cycle not finished. 2."Auto flushing" is set to "OFF". 3.Angle valve is closed. 4.A power or water outage occurred. 	<ol style="list-style-type: none"> 1.Wait until the previous cycle finishes then flush. 2.Long press "Full flush" button on the remote to turn it "ON". 3.Turn on the angle valve. 4.Wait until the power or water is restore, meanwhile use a bucket to manually flush.
Toilet does not flush completely	<ol style="list-style-type: none"> 1.Water supply hose is kinked. 2.Angle valve is not fully open. 3.Filter screen is clogged. 4.The supplied angle valve was not installed. 5.The water supply to the toilet is disrupted by other running water fixtures. 	<ol style="list-style-type: none"> 1.Straighten the water hose. 2.Open the angle valve fully. 3.Refer to the user manual "Filter Maintenance" Section. 4.Install the original angle valve which has a filter included. 5.Cease using other fixtures then flush the toilet.
Spray rod does not function properly	<ol style="list-style-type: none"> 1.Water failure. 2.Power failure. 3.Angle valve is closed. 4.Unseated or user is not detected by the toilet seat. 5.Filter or water inlet tube for spray rod is clogged 	<ol style="list-style-type: none"> 1.Wait until the water supply is restored 2.Wait until the power is restored. 3.Turn on the angle valve. 4.Cover the "Sensor Area" on the toilet seat. 5. To clean the filter, refer to the user manual "Filter Maintenance" Section. <p>For unclogging water inlet tube, consult Support for instructions.</p>
Operations stop in the middle of the use	<ol style="list-style-type: none"> 1.The drying feature stops automatically after about 3 minutes of continuous use. 2.The cleaning feature stops automatically after about 3 minutes of continuous use. 3.User is not detected by the toilet seat. 	<ol style="list-style-type: none"> 1.Press "Dry"button on the remote if needed. 2.Press cleaning button on the remote if needed. 3.Cover the "Sensor Area"on the toilet seat.
Auto open/close lid does not function properly	<ol style="list-style-type: none"> 1.User is standing slightly out of sensible range. 2.Toilet is in "Standby" mode. 3.Product is under protected status. 4.Power failure occurred. 	<ol style="list-style-type: none"> 1.Stand right in front of the toilet. 2.Long press the side knob to switch to "Functional" mode. 3.Press "TEST" then "RESET". on the leakage protection plug. 4.Wait until the power is restored.

Symptoms	Probable Causes	Recommend Action
Toilet leak	<ol style="list-style-type: none"> 1.Pipe fittings are loose 2.Foreign objects on water sealing piece 	<ol style="list-style-type: none"> 1.Firmly tighten the fittings 2.Remove any objects on water sealing piece (If the water is still leaking, close the angle valve and consult Support for instructions.)
Night light does not work	<ol style="list-style-type: none"> 1.Night light setting is currently on "Manual Mode" 2. Night light parts have issues. 	<ol style="list-style-type: none"> 1.Long press "Night light" on the remote to switch to "Intelligent mode" 2.Contact Support for further instructions.
Remote control does not work	<ol style="list-style-type: none"> 1.The batteries were inserted in the wrong direction. 2.The batteries have expired. 	<ol style="list-style-type: none"> 1.Re-load the batteries in the correct direction. 2.Change new batteries.
Auto pre-wetting does not work	<ol style="list-style-type: none"> 1."Auto pre-wetting" is set to "OFF". 2.User is not detected by the toilet seat. 	<ol style="list-style-type: none"> 1.Press and hold "Stop" on the remote, then press "Full flush" to turn on "Auto pre-wetting". 2.Cover the "Sensor Area" on the toilet seat.
Low water temperature	The water temperature is not set properly.	Adjust the water temperature by pressing "Water Temp" on the remote, check the indicator light for the temperature level.
Low seat temperature	<ol style="list-style-type: none"> 1.The seat temperature is not set properly. 2.Toilet is in "Energy Saving" mode 3.Toilet is in "Standby" mode 	<ol style="list-style-type: none"> 1.Adjust the seat temperature by pressing "Seat Temp" on the remote, check the indicator light for the temperature level. 2.Long press "Stop" on the remote to exit "Energy Saving". 3.Long press the side knob to switch to "Functional" mode.
Low drying air temperature	The drying air temperature is not set properly.	During drying, press "Dry Dry Temp" on the remote to set the air temperature, check the indicator light for the temperature level.

Notice: Clean the toilet with a (non-abrasive) neutral toilet detergent.



Caution

Please try to reconnect the power to solve the problems.

If the problem still cannot be resolved, please disconnect the power and contact service providers.

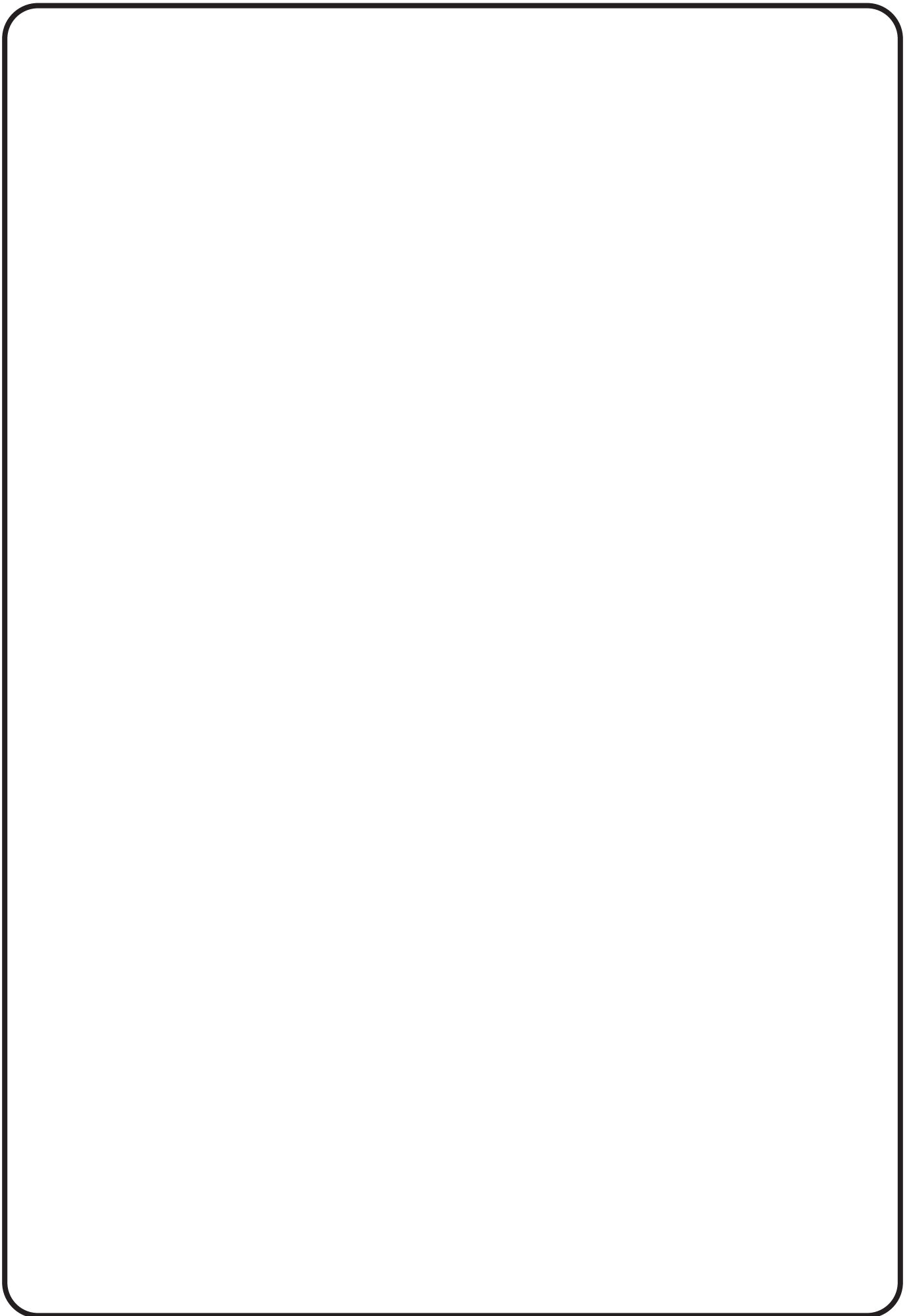

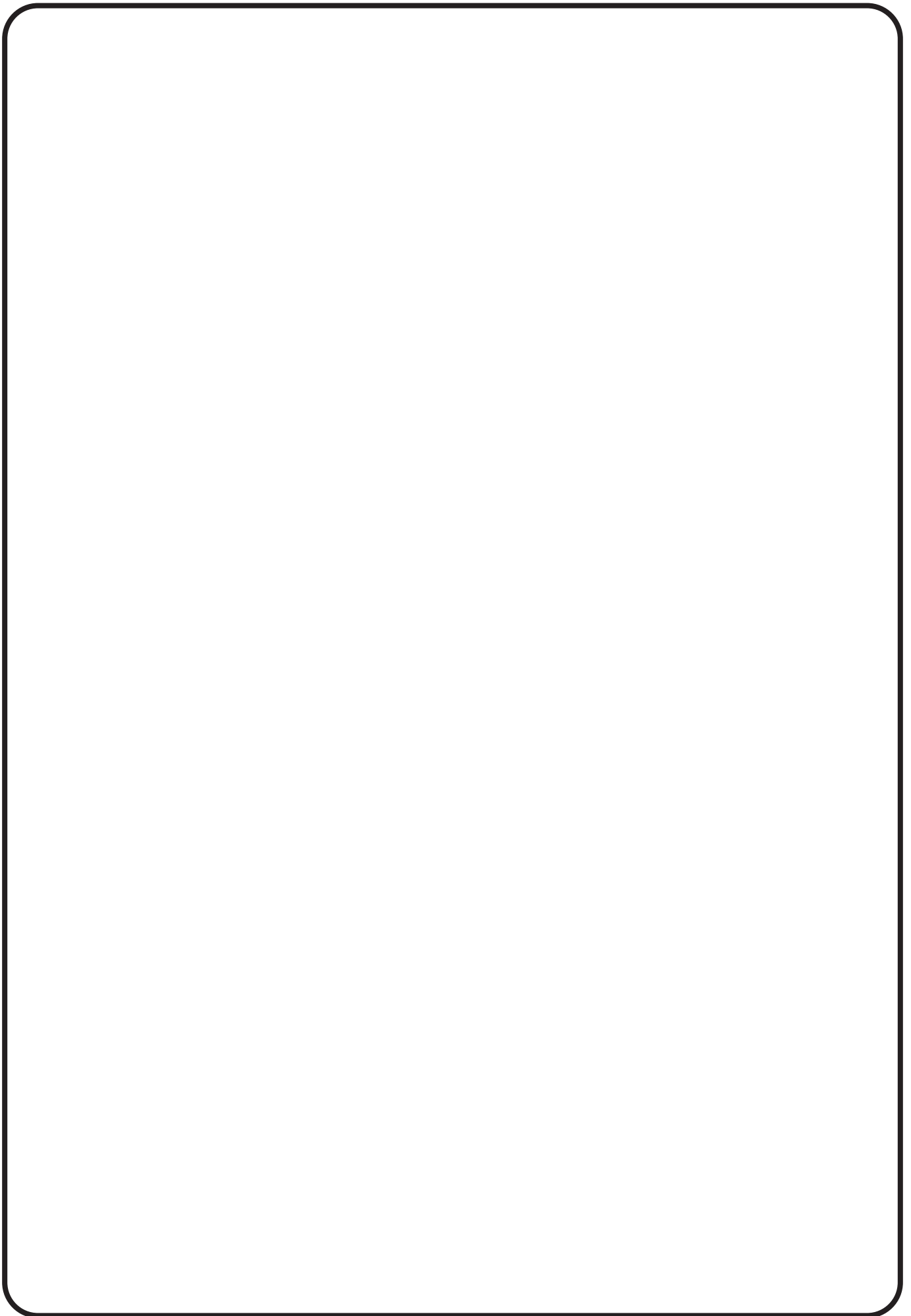

Thank you for choosing I.DEER products

Customer Service

Phone: [949]-294-8030

Email: support@ideer.land

ASVFAF0450004A-1.0