

# User Manual

# i.DEER

## Series C8

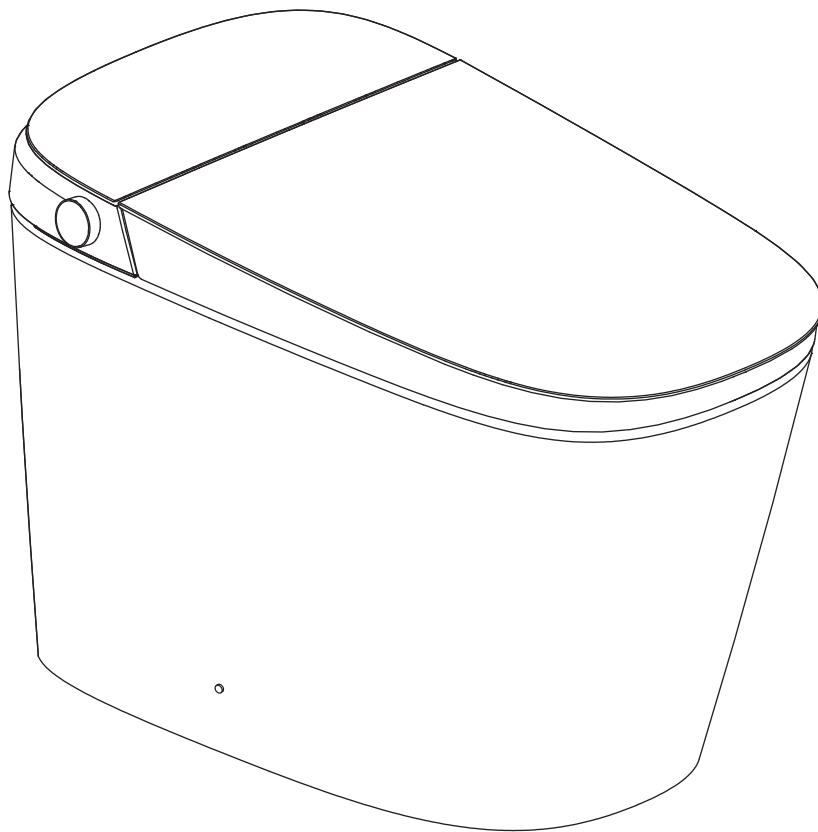

**Compliance with**  
**cUPC** [Uniform Plumbing code]  
**EGS** [IAPMO - Electrical Product]



UL 1431  
CSA C22.2  
Nos.64 and 68

[www.ideer.land](http://www.ideer.land)

# Table of Content

<b>Toilet Schematic</b>	<b>01</b>
<b>Remote Guide</b>	<b>02</b>
<b>Rear/Front washing</b>	<b>03</b>
<b>Drying/Dryer temperature</b>	<b>03</b>
<b>Water volume adjustment</b>	<b>04</b>
<b>Nozzle position adjustment</b>	<b>04</b>
<b>Energy saving</b>	<b>04</b>
<b>Water temperature adjustment</b>	<b>04</b>
<b>Seat temperature adjustment</b>	<b>05</b>
<b>Night light</b>	<b>05</b>
<b>Full flush/Half flush</b>	<b>05</b>
<b>Open/close lid and seat</b>	<b>06</b>
<b>Auto deodorization</b>	<b>06</b>
<b>Other operations</b>	<b>07</b>
<b>User code</b>	<b>08</b>
<b>Radar sensing auto open lid</b>	<b>09</b>
<b>Foot Sensor</b>	<b>10</b>
<b>Knob function</b>	<b>11</b>
<b>Indicator light description</b>	<b>13</b>
<b>Maintenance</b>	<b>14</b>
<b>Emergency Solution</b>	<b>16</b>
<b>Product Limited Warranty</b>	<b>18</b>

Thank you for choosing our product. Please read the instructions carefully before initial use and keep it available for future maintenance or reference.

# Toilet Schematic

## Left View

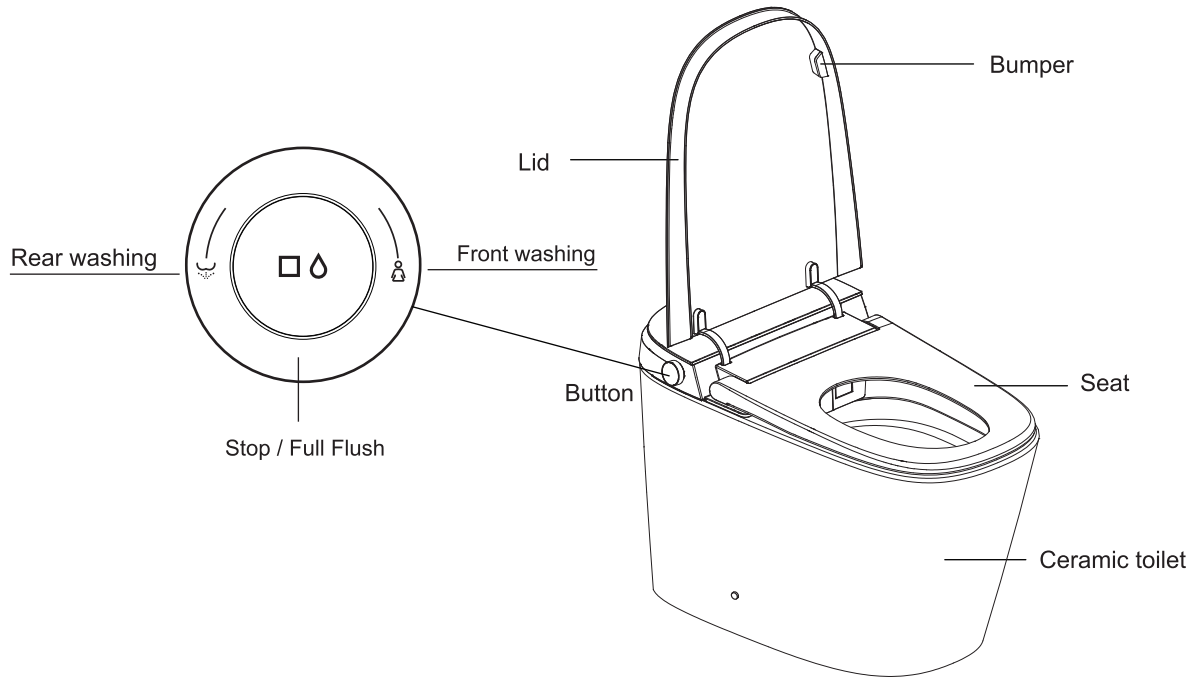

## Right View

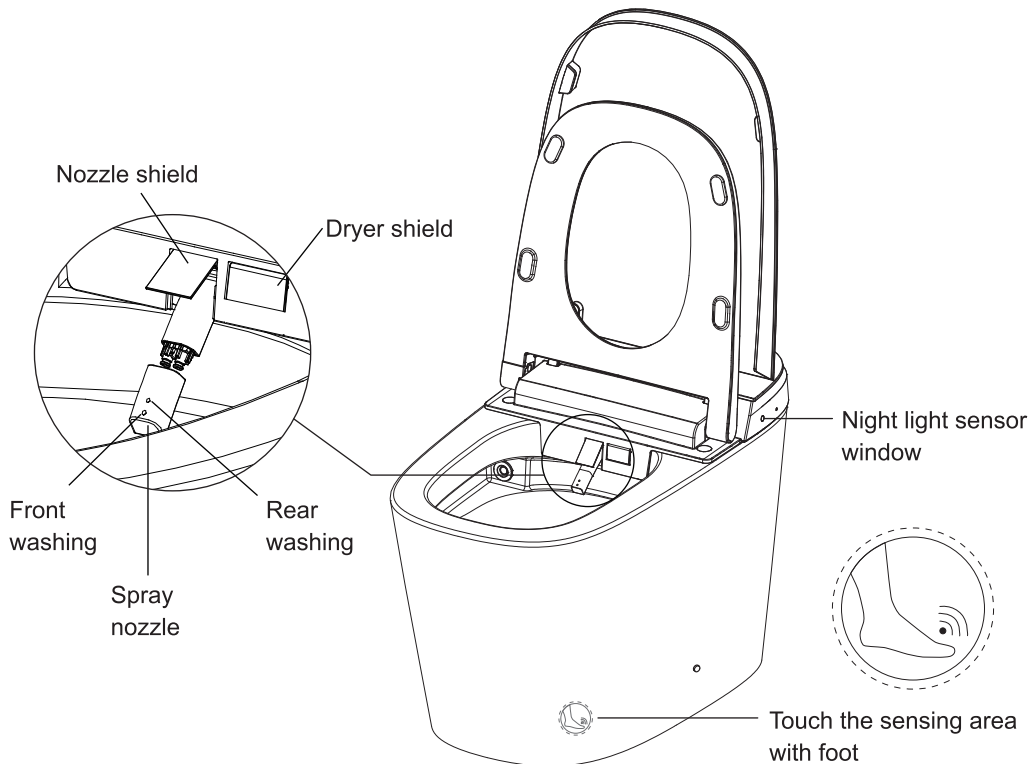

# Remote Guide

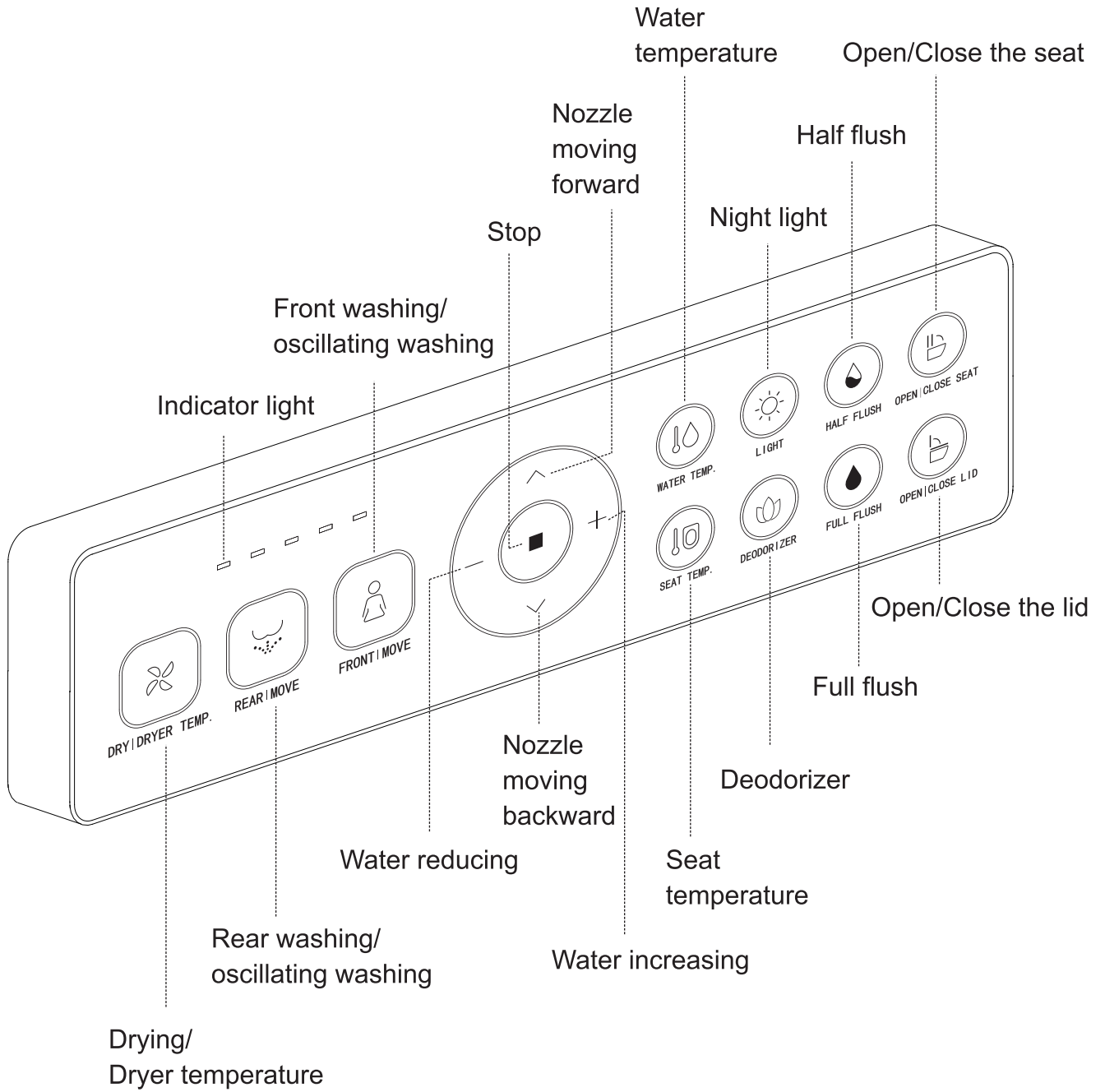

# Remote Usage Instruction

Notice :



Only when the user is seated and the buzzer beeps can the functions of front/rear washing and drying be activated.

Please sit backward on the seat for correct washing position and to avoid splashing.

The nozzle will continue to spray for 1-2 seconds after user stands up during washing, so please press "STOP" button before standing up.



## REAR | MOVE



Press "  " button, the indicator light is on showing current water temperature level, it starts rear washing; Press again "  " button to shift to oscillating washing (nozzle moves forward and backward to expand washing area). The washing will stop automatically after one cycle, while it will stop immediately if the user presses "  " button.

## FRONT | MOVE



Press "  " button, the indicator light is on showing current water temperature level, it starts front washing; Press again "  " button to shift to oscillating washing (nozzle moves forward and backward to expand washing area). The washing will stop automatically after one cycle, while it will stop immediately if the user presses "  " button.

## DRY | DRYER TEMP



Press "  " button, the indicator is on, showing the current air temperature level. It will stop drying automatically after one cycle or after leaving.

Under drying, press "  " button to adjust the air temperature between 0-5 level, and the indicator light is on showing the air temperature level. When the indicator light is off, the temperature is at level 0 (room temperature).

○ ○ ○ ○ ○  
Room  
temperature

● ○ ○ ○ ○  
Level 1

● ● ○ ○ ○  
Level 2

● ● ● ○ ○  
Level 3

● ● ● ● ○  
Level 4

● ● ● ● ●  
Level 5

## Water volume adjustment

Press " + " or " - " button when it is under function of Rear Washing or Front Washing, the indicator light is on showing current water volume level, and water volume can be adjusted.

## Nozzle position adjustment

Press " ^ " or " v " button when it is under function of Rear Washing or Front Washing, the indicator light is on showing current nozzle position, and nozzle position can be adjusted in 5 levels.

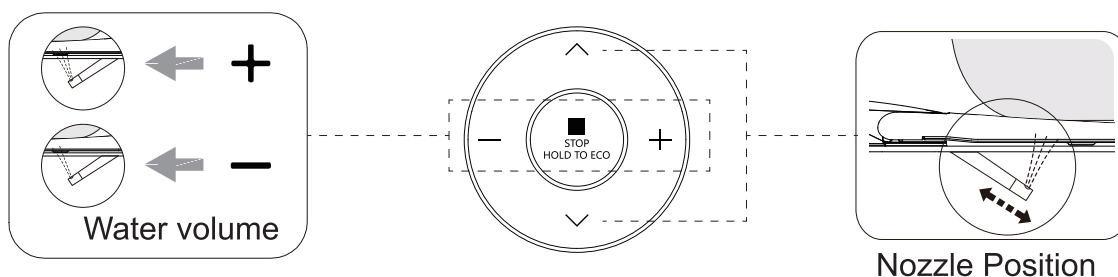

## Energy saving

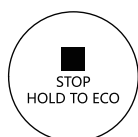

Long press " ■ " button to enter energy saving mode, long press " ■ " button again to exit energy saving mode.

Under energy saving mode, seat temperature is set to Level 1 for energy saving. (Note: If the seat temperature before energy saving is neutral, then it will be neutral as well.)

Remark:

If the toilet is used, the product will automatically switch from energy saving mode to functional mode. The seat will start heating immediately (without turning off the seat temperature), and the energy saving mode is restored once the toilet is unseated.

## Water temperature adjustment



Short press " 🌡️ " button to adjust the water temperature between 0-5 level. The indicator light is on showing current water temperature level. When the indicator is off, the temperature is at level 0 (room temperature).

○ ○ ○ ○ ○  
Room  
temperature

● ○ ○ ○ ○  
Level 1

● ● ○ ○ ○  
Level 2

● ● ● ○ ○  
Level 3

● ● ● ● ○  
Level 4

● ● ● ● ●  
Level 5

## Seat temperature adjustment



SEAT TEMP.

Short press "🪿" button to adjust the seat temperature between 0-5 level. The indicator light is on showing current seat temperature level. When the indicator is off, the temperature is at level 0 (room temperature).



Room temperature



Level 1



Level 2



Level 3



Level 4



Level 5

## Night light

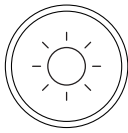

LIGHT

Night light adjustment: Short press "☀️" button to turn on/turn off night light.

Intelligent mode: Long press "☀️" button to enter into intelligent mode (Night light will be on or off depending on the surrounding light.).

If the product is on intelligent mode, short press "☀️" button to exit intelligent mode.

(Factory setting: intelligent mode)

## Half flush / Full flush



HALF FLUSH

Short press "💧" button, the toilet starts half flushing.

Short press "💧" button, the toilet starts full flushing.

Long press "💧" button to turn on/off auto flush function.



FULL FLUSH

When the auto flush function is turned on, toilet will automatically flush after detecting user leaving the seat.

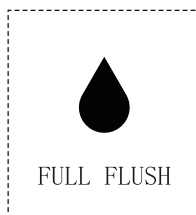

FULL FLUSH

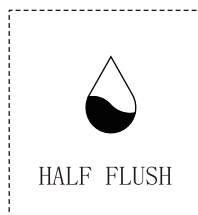

HALF FLUSH

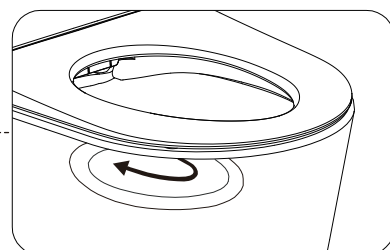

## Open/close lid and seat





OPEN|CLOSE THE LID

Short press "  " button to open or close the lid.



OPEN|CLOSE THE SEAT

Short press "  " button to open or close the seat.

Long press "  " button to turn on/off auto lid open/close function.

## Auto deodorization

Short press "  " button to turn on/off auto deodorization function.

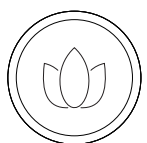

DEODORIZER

The deodorization function will be automatically turned on when the user is seated, and will stop after leaving.

Under drying, deodorization will stop.

(This function is turned on by default.)



# Other operations

## Quiet mode

Press and hold the " ■ " button and press the "  " button to turn on/off quiet mode.

## Sterilization function

When no one seated long press "  " button to turn on plasma sterilization function. This function will stop automatically after 2 hours. Under this mode, if any other button is pressed or user is seated, it will stop automatically.

## Automatic pre-wetting function

Press and hold " ■ " button and press "  " button to turn on or off automatic pre-wetting function. After the automatic pre-wetting function is turned on, the pre-wetting function will be performed when the user is detected to be seated. (Only for the toilet with automatic pre-wetting function.)

## Foot sensor function

Long press "  " button to turn on/off foot sensor function. Foot sensor is deactivated when the user is seated.

# User code

## Radio frequency remote control

Turn off the power supply of toilet

Press and hold " ■ " button, then press "  " button, the indicator light will flash.

Reconnect the power plug and press "reset" button on the leakage protection plug

The indicator stops flashing and stays on for 2 seconds, indicating that the remote control and the toilet are matched successfully. It beeps once when the self-inspection completes. Then the remote control is ready for use.

Remark:

In case of power cut during nozzle spraying, the wand cannot be retracted, please wait until the power is restored. In case of a power cut for a long period, please push the wand softly back by hand. Do not push hard, to avoid damage to wand and electrical machine.

# Radar sensing auto open lid

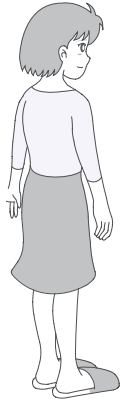

## Approaching the toilet

When user approaches to the sensing area, the lid will open automatic.

(The sensor located near the LED Screen, so the sensing area is right in front of the toilet. The sensibility is slightly weak on the side.)

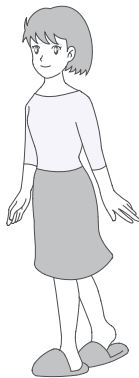

## Leaving the toilet

The seat lid closes automatically 180 seconds after user leaves.



## Leaving after urinating standing

The seat and lid close automatically 180 seconds after user leaves.

# Foot sensor

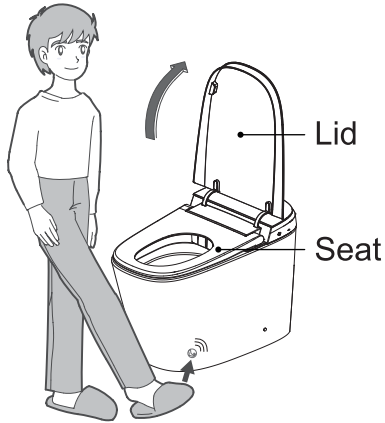

1. If the lid and seat are both closed, touch the sensing area with foot to open the lid.

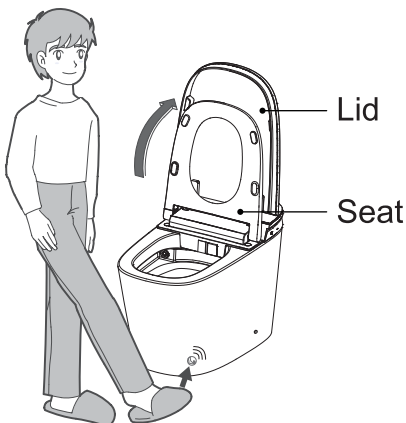

2. If the lid is open and seat closed, touch the sensing area with foot to open the seat.

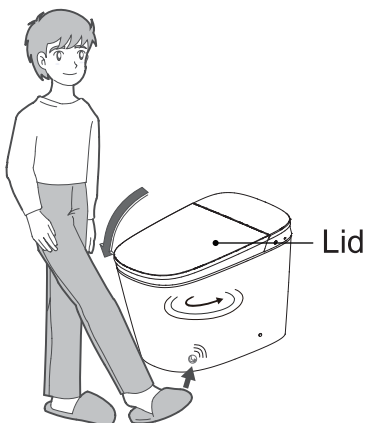

3. When the seat and lid are both open, use the toilet then touch the sensing area with foot to close the seat and lid while activating a half flush.

# Knob function

When seated, rotate the knob clockwise to activate the front washing function, and rotate the knob counterclockwise to activate the rear washing function.

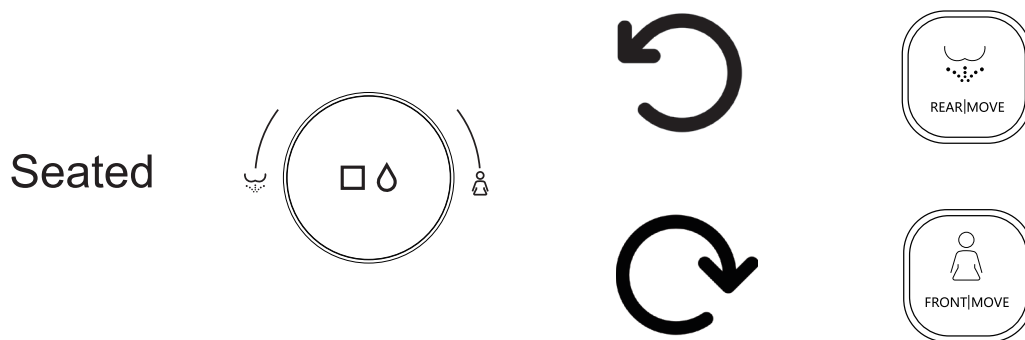

When no one is seated, turn the knob clockwise to start the manual cleaning function of the nozzle.

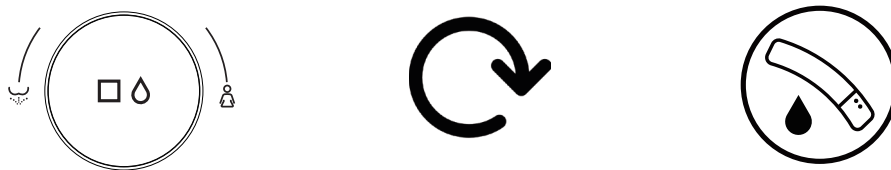

During rear and front washing, turn the knob clockwise to move the spray wand forward, and counterclockwise to move the spray wand backward;

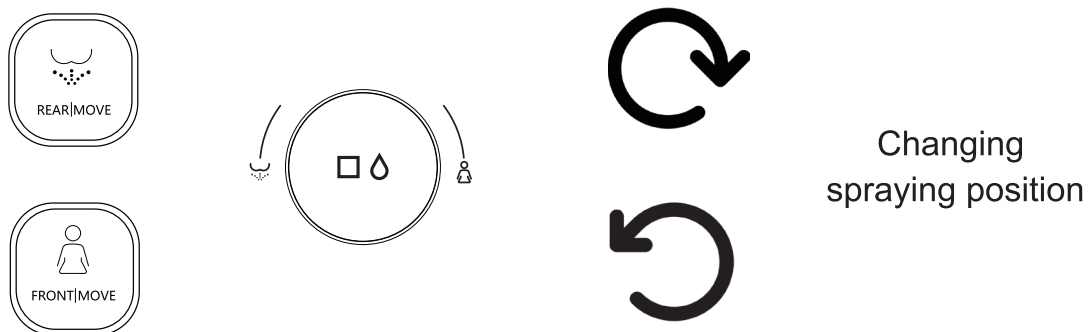

During rear and front washing, long press the knob to switch to the water pressure adjustment function. Clockwise rotation increases the water pressure, while counterclockwise rotation decreases the water pressure.

Note:

During washing, long press the knob to switch between the functions of water pressure adjustment and spray wand position adjustment.

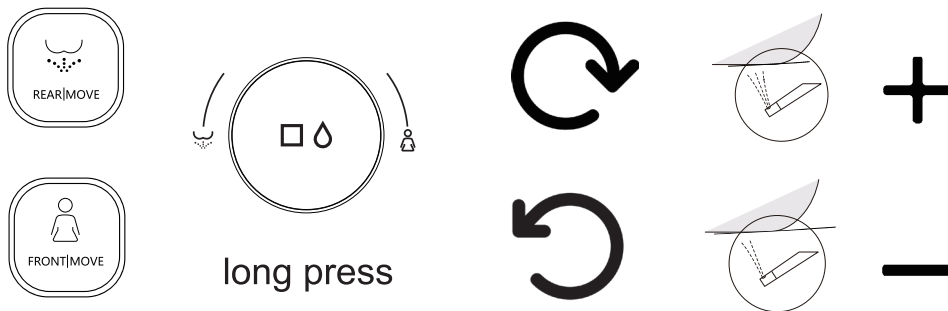

During drying, clockwise rotation increases air temperature and counterclockwise rotation decreases air temperature.

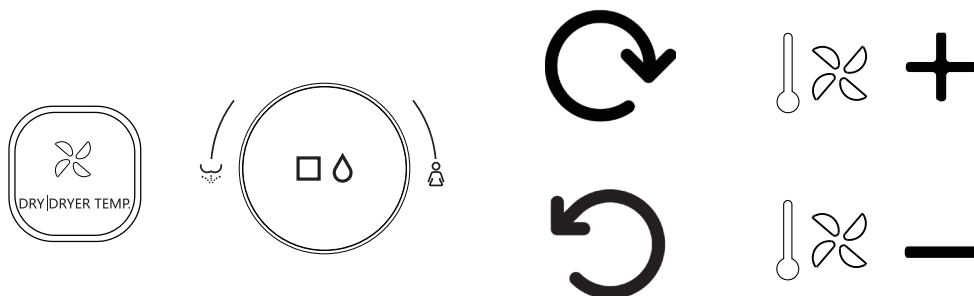

In functional mode, press the knob to stop function in progress: rear washing, front washing, drying or nozzle cleaning.

In addition, press the knob to flush the toilet.

To change between standby and functional mode, press and hold the knob.

Note: When the main unit is turned on, all function gears default to the middle setting. If the remote control is used, it will switch to the function gear set by the remote control.

# Indicator light description

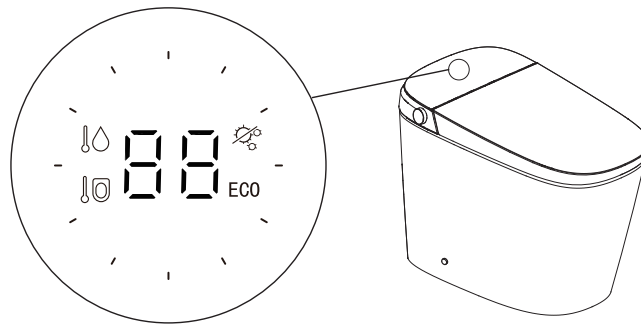

88

Temperature: When the water temperature indicator light is on, it will display the water temperature, and when the seat temperature indicator light is on, it will display the seat temperature; the preset temperature will display [--].

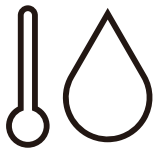

Water temperature: When adjusting the water temperature, the water temperature indicator light is on, In the cleaning state, the water temperature indicator light is on.

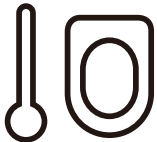

Seat temperature: When the unit is turned on and not in the cleaning mode, the seat temperature indicator light is on by default.

ECO

Energy saving: When the energy saving indicator light is on, it means that the unit is in an energy saving mode.



Sterilization function: When the sterilization function is enabled, the sterilization icon will light up, otherwise it will go off.

## Note

When the toilet is unused, all the indicator lights will go out after a period of time, and the indicator lights will return to display when any function is used again.

# Maintenance

## Main unit care and maintenance

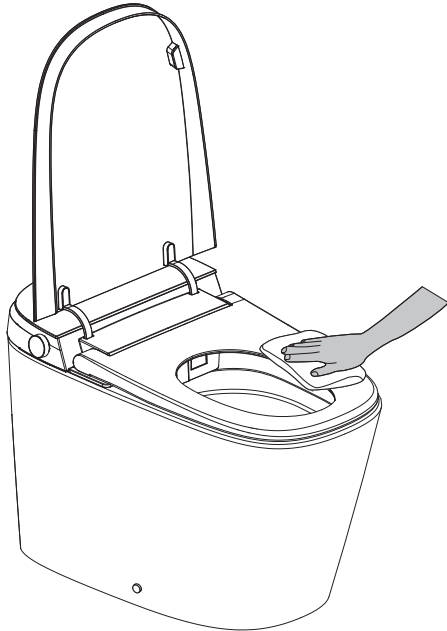

1. Shut down power supply before doing maintenance.
2. Use only a soft, damp cloth to clean. Avoid using harsh chemicals.
3. Once cleaning is completed and all surfaces are dry, re-connect the power plug.

## Spray nozzle maintenance and care

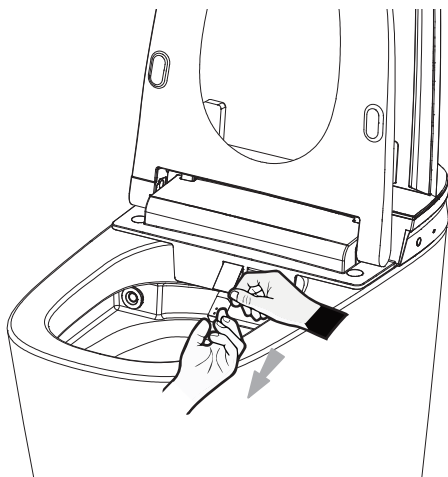

1. When no one is seated, turn the knob clockwise. The nozzle will automatically stretch out to allow access for cleaning.

2. When the nozzle moves forward, the nozzle can be removed and cleaned separately.

3. Use only a soft cloth or soft brush to clean. Do not pull or push the wand, to avoid damage.

4. Put the nozzle back and short press the “Stop” button to return the spray wand to its normal position.

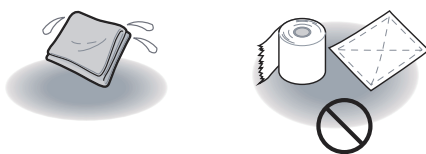



## Filter maintenance

If poor spray performance occurs under normal conditions:

1. Turn off power and the angle valve
2. Unscrew angle valve nut
3. Remove filter net

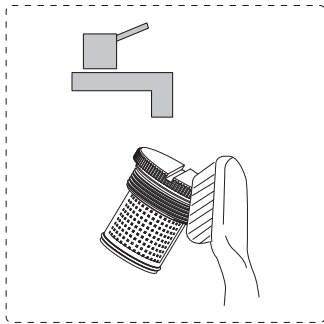
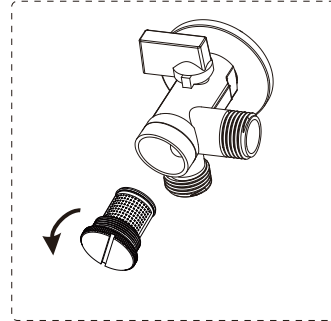

4. Clean out the filter net under running water using a toothbrush
5. Reinstall filter and angle valve nut.
6. Turn on the angle valve and connect power.

# Emergency Solution

## water failure

1. No water

Put around 2.1Gal (8L) water into a barrel to flush the ceramic bowl.

Note: Avoid water spilling from bowl.

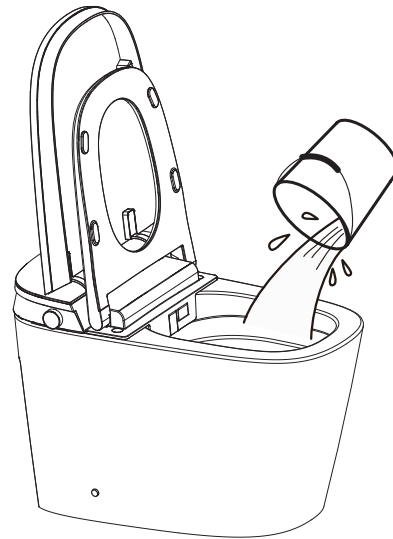

## Failure of remote control

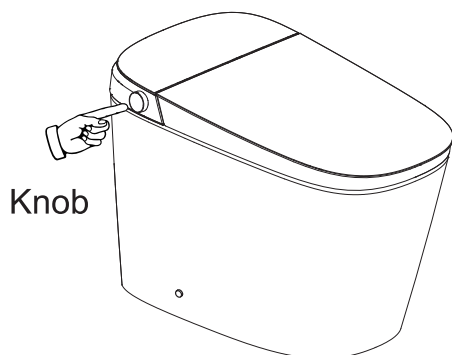

Knob

1. Operate via the knob on the main unit.

2. Battery replacement

- Remove the remote control from holder.
- Open the battery cover and replace the batteries.
- Put the remote control back.

Note:

After battery replacement, the remote control settings will be restored to the defaults. Please reset.

## Product unused for a period of time

When the product is left unused for a long time, especially in cold weather, it is highly recommended to drain the water to prevent freezing.

To discharge water

1. Activate flushing, and then turn off angle valve to stop water supply.
2. Unplug and cut off the electricity
3. Disconnect the hose from angle valve, drain the water and reconnect.
4. For your safety, it is recommended to put antifreeze into the remaining water in the bowl.

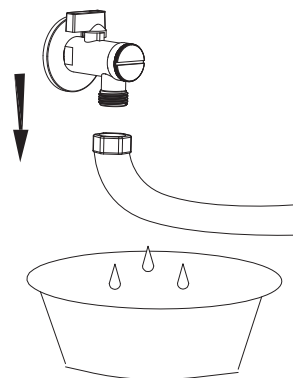

\* Please turn on power and water supply when using again.



Note: Before water discharging, the power must be cut off!

The picture of product may not entirely consistent with actual appearance and color because of product improvements, please in kind prevail.

# Product Limited Warranty

## I.DEER Smart Bidet Toilet C8 Series Three Year Limited Warranty

I.DEER Trading Inc (I.DEER) warrants its toilets with integrated cleansing functionality ( "Smart Bidet Toilets") to be free of defects in material and workmanship during normal residential usage for three (3) years from date of purchase. This warranty applies only to I.DEER products purchased and installed in North America.

I.DEER will, at its election, repair, replace or make appropriate adjustment where I.DEER inspection discloses any such defects occurring in normal usage. Damage caused by accident, misuse or abuse is not covered by this warranty. Improper care and cleaning will void the warranty.\* Proof of purchase (original sales receipt) must be provided to I.DEER with all warranty claims. I.DEER is not responsible for removal, installation, labor charges, or other incidental or consequential costs. In no event shall the liability of I.DEER exceed the purchase price of the product.

If you believe that you have a warranty claim, contact I.DEER, either through your Dealer, Plumbing Contractor, Online E-Commerce Platform or by contact I.DEER through its website [www.ideer.land](http://www.ideer.land). Please be sure to provide all pertinent information regarding your claim, including a complete description of the problem, the product, model number, the date the product was purchased and from whom the product was purchased. Also include your proof of purchase (original sales receipt).

I.DEER AND/OR SELLER ARE PROVIDING THESE WARRANTIES IN LIEU OF ALL OTHER WARRANTIES, EXPRESSED OR IMPLIED, INCLUDING BUT NOT LIMITED TO THE IMPLIED WARRANTIES OF MERCHANTABILITY AND FITNESS FOR A PARTICULAR PURPOSE. I.DEER, AND/OR SELLER DISCLAIM ALL LIABILITY FOR SPECIAL, INCIDENTAL OR CONSEQUENTIAL DAMAGES. Some jurisdictions do not allow limitations of how long an implied warranty lasts or the exclusion or limitation of such damages, so these limitations and exclusions may not apply to you. This warranty gives the consumer specific legal rights. You may also have other rights that vary from jurisdiction to jurisdiction.

Never use cleaners containing abrasive cleansers, ammonia, bleach, acid, waxes, alcohol, solvents or other products not recommended for stainless steel or polypropylene plastic. This will void the warranty.

**Thank you for choosing I.DEER products**

**Customer Service**  
**Email: [support@ideer.land](mailto:support@ideer.land)**  
**Phone: [949] 294 8030**

ASVFAF0450005A-1.0